

① [**Projet 01**]
TRIPLEX **Dessin :**
EAU DOMESTIQUE

EFD = Eau Froide Domestique
ECD = Eau Chaude Domestique

② Présentation
Mise en Page
=
Page 50

Conception en Plan
③ (À REPRODUIRE)
=
Sous-Sol Page 51
Rez-De-Chaussée Page 52
Niveau 2 Page 53
Niveau 3 Page 54

① Dans
**Arborescence
de projet**
Du Module 12

- 📁 PLO_Projet 01_Triplex
 - 📁 Projet 1 - Plans CAD Mecanique
 - 📄 Projet_01_P-dra.dwg
 - 📄 Projet_01_P-dra.dwg
 - 📄 Projet_01_XR-crt.dwg
 - 📄 Projet_01_XR-arch.dwg

Copier

② Dans
**Arborescence
de projet**
Du Module 12

- 📁 PLO_Projet 01_Triplex
 - 📁 Projet 1 - Plans CAD Mecanique
 - 📄 Projet_01_P-dra.dwg
 - 📄 Projet_01_P-dst.dwg
 - 📄 Projet_01_XR-crt.dwg
 - 📄 Projet_01_XR-arch.dwg

Renommer

③ Dans
**Arborescence
de projet**
Du Module 12

- 📁 PLO_Projet 01_Triplex
 - 📁 Projet 1 - Plans CAD Mecanique
 - 📄 Projet_01_P-dst.dwg

*Ouvrir
[CTRL + O]*

Page 50 ①

Renommer l'onglet Pour M-03

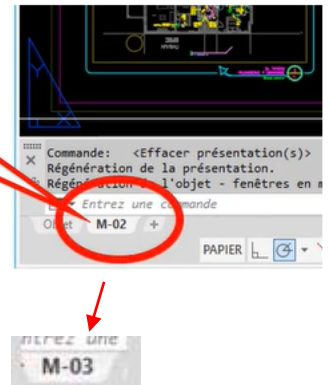

③

À l'intérieur des viewports, EFFACER toute la conception de drainage et d'évent

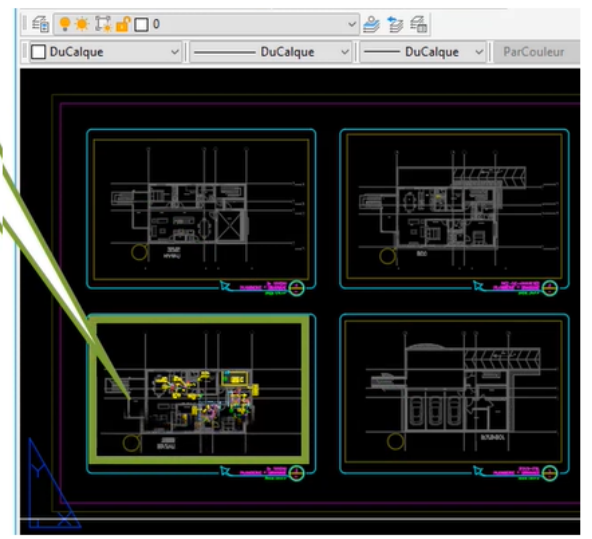

Page 50 ②



Modifier les informations au Cartouche

④

RE-TITRER chacune des vues

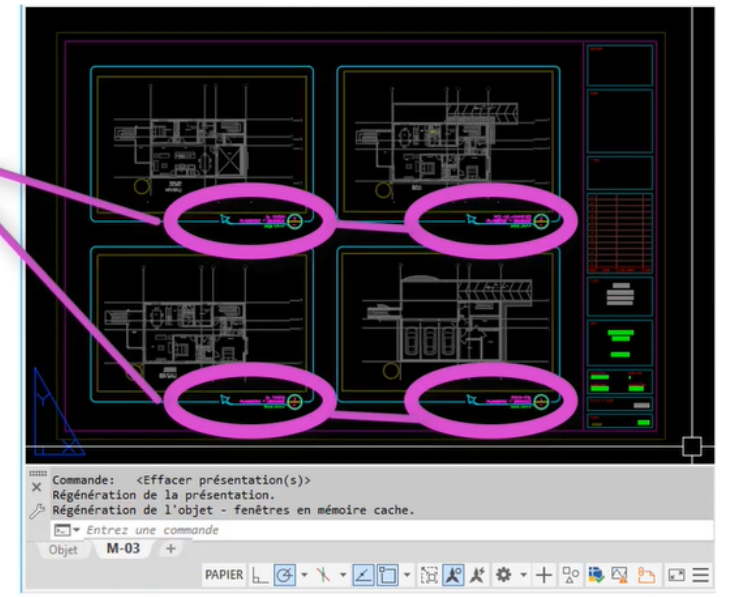

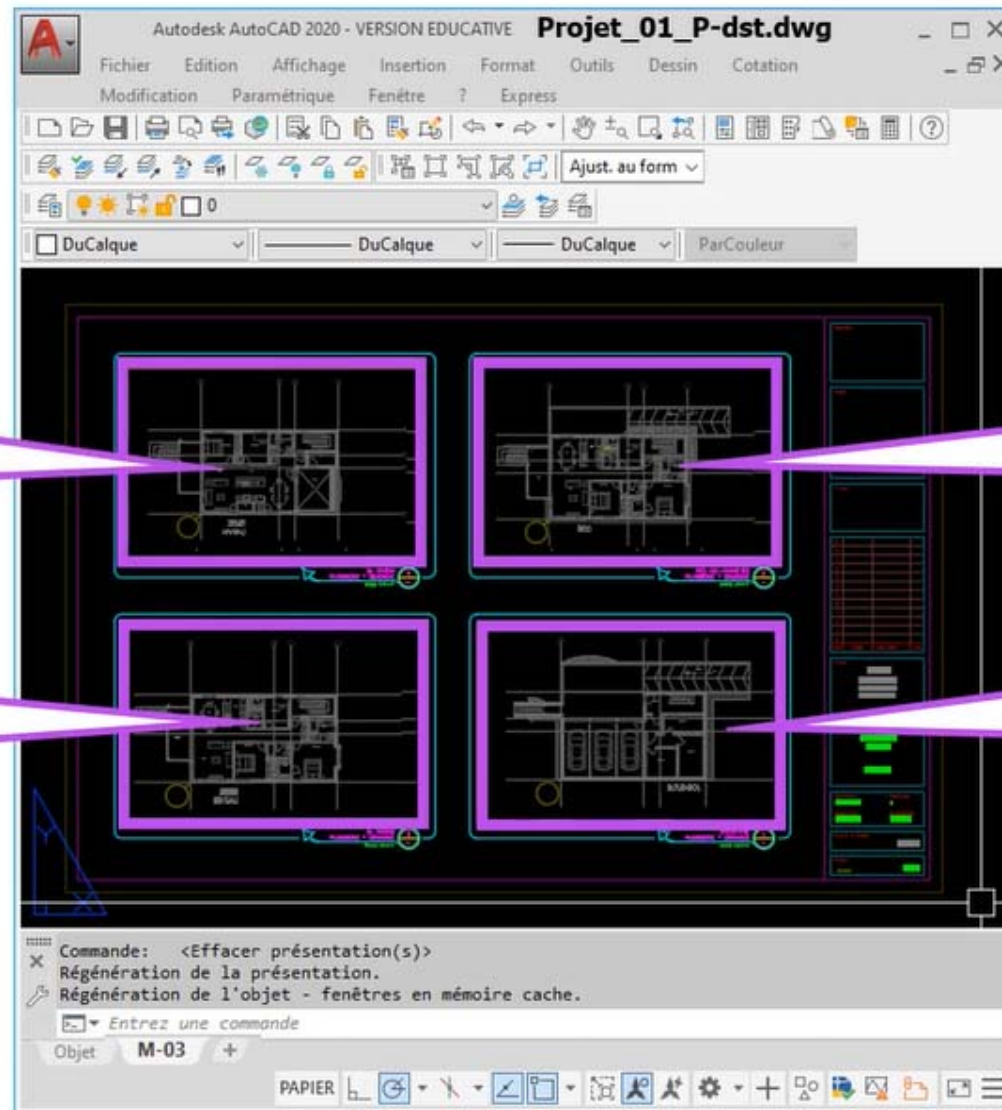

DESSINEZ

Alimentation
NIVEAU 3
Page 54

Alimentation
REZ-DE-CHAUSSÉE
Page 52

Alimentation
NIVEAU 2
Page 53

Alimentation
SOUS-SOL
Page 51

Projet_01_P-dst.dwg

E..	Nom	A.	G.	V.	T.	Couleur	Type de ligne	Epaisseur de ligne
P-ECD-N						21	ECD imp	Par_défaut
P-EFD-N						151	EFD imp	Par_défaut
P-TXT-N						jaune	Continuous	Par_défaut

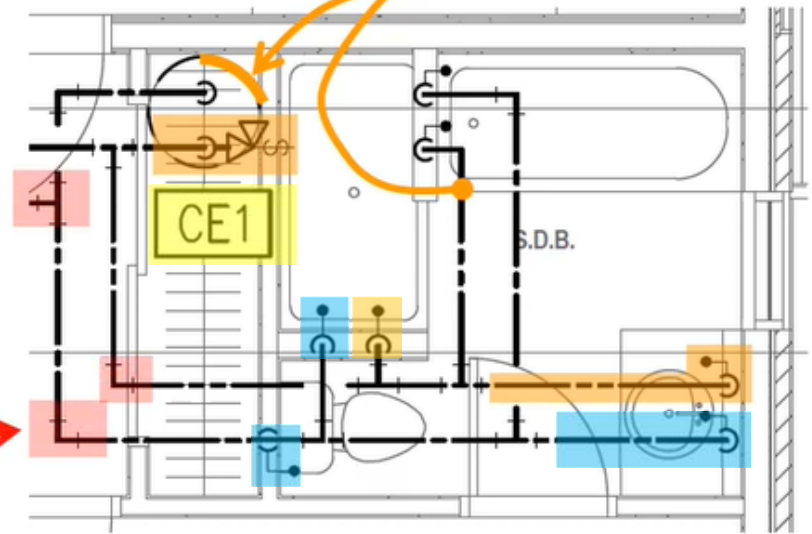
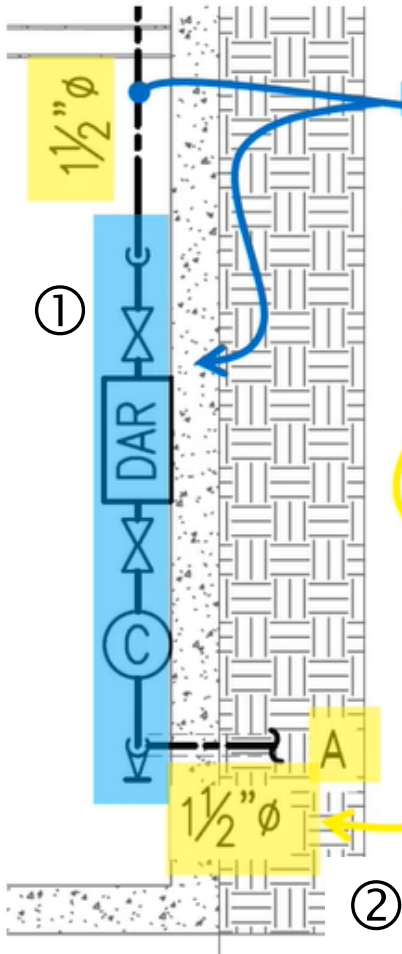

P-JONCTIONS						red	Continuous	Default
-------------	--	--	--	--	--	-----	------------	---------

Projet_01_P-dst.dwg

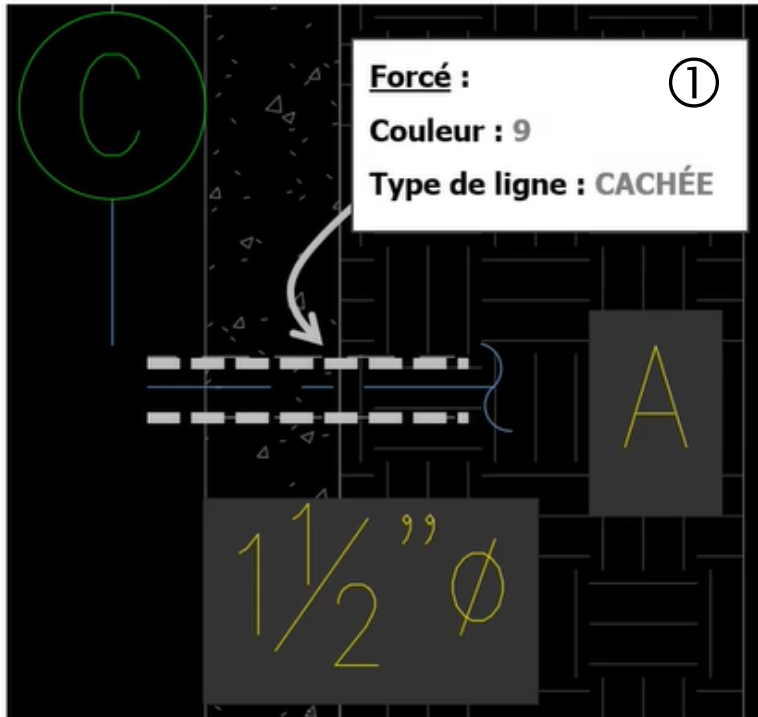



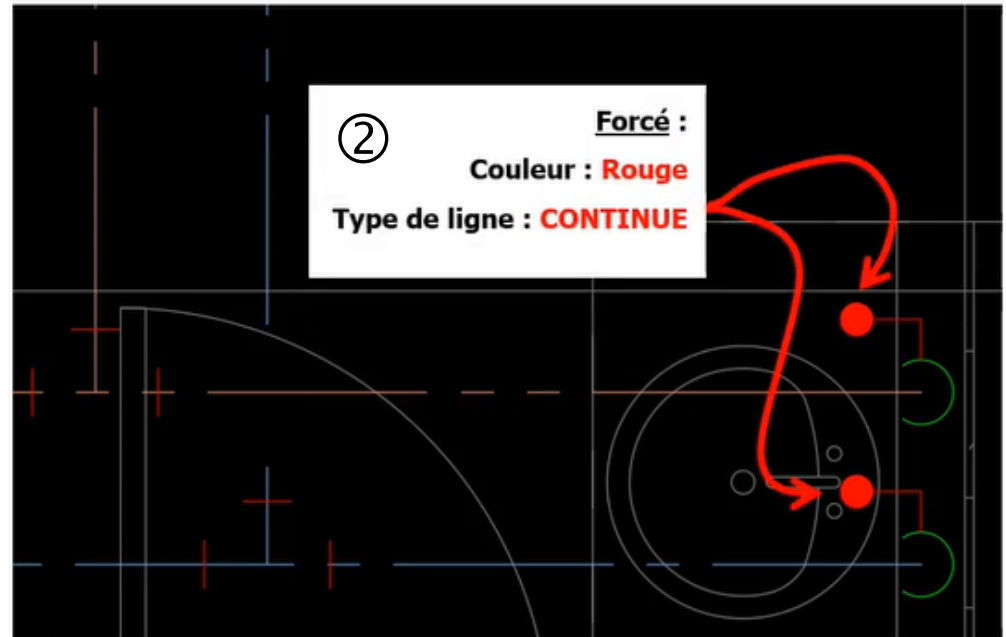





Projet_01_P-dst.dwg



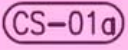









1 IDENTIFICATION

① Page P-3

=
**SYMBOLES
 + BLOCS
 AVEC TEXTE
 / ATTRIBUT**
 =
**À INSÉRER
 SELON
 HAUTEUR DE
 TEXTE DU
 VIEWPORT**

 P01_Id_01.dwg	 P01_Id_05.dwg <small>Exploser</small>
 P01_Id_03.dwg	 P01_Id_07.dwg <small>Exploser</small>
 P01_Id_04.dwg	 P01_Arrow_Extrait.dwg <small>Exploser</small>
 P01_Id_08.dwg	 P01_Encer.dwg





2 SYMBOLES

 P02_Dn01.dwg <small>Exploser</small>	 P02_Junction_090.dwg
 P02_Dn02.dwg <small>Exploser</small>	 P02_Junction_180.dwg
 P02_Up01.dwg <small>Exploser</small>	 P02_Junction_360.dwg
 P02_Up02.dwg	 P02_Squidel.dwg
 P02_Arrow.dwg	 P02_Cap.dwg



5 ÉQUIPEMENTS

②

Page P-3
 =
ÉQUIPEMENT
 =
**VRAI
 DIAMÈTRE
 24"Ø**

 P05_Compteur.dwg
 P05_DAR.dwg
 P05_CE.dwg P05_CE_suspendu.dwg
 P05_RAI.dwg <small>Exploser</small>

4 VALVES & CLAPETS

 P04_Valve01.dwg <small>Exploser</small>	 P04_Valve16.dwg <small>Exploser</small>
 P04_Valve04.dwg	 P04_Valve11.dwg
 P04_Valve10.dwg	 P04_Valve12.dwg
 P04_Valve05.dwg	 P04_Valve14.dwg
 P04_Valve09.dwg	 P04_Valve06.dwg